

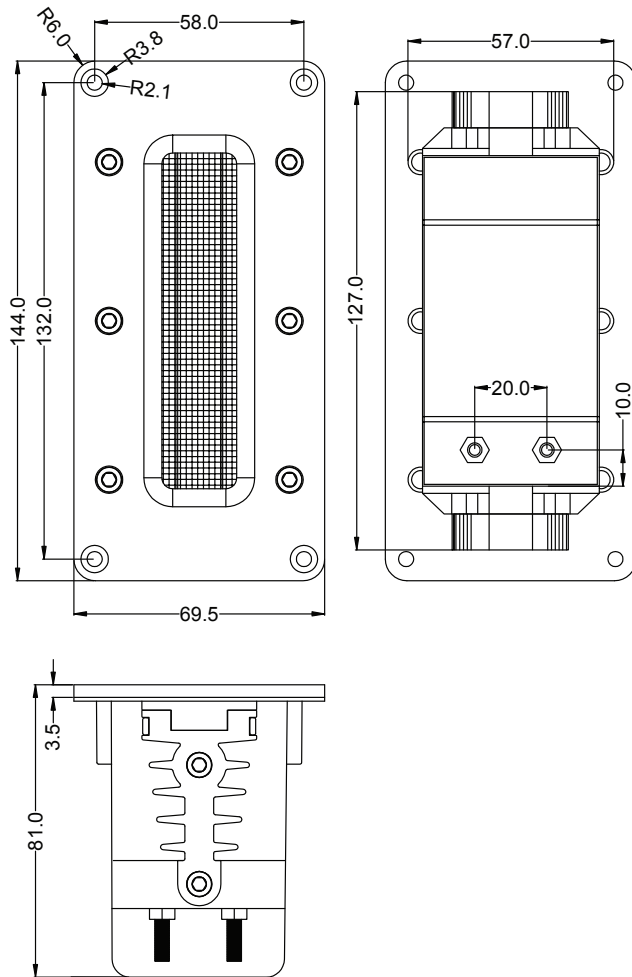

RT3.0-8 HI-RES NEO RIBBON TWEETER 8 OHM

MECHANICAL DRAWING



FEATURES

- 2.3kHz to 40kHz frequency response for true Hi-Res detail
- Powerful neodymium magnets deliver high efficiency and incredible dynamics
- Remarkably thin ribbon diaphragm provides accurate transient detail
- High sensitivity for increased SPL Output
- Built-in grill protects the delicate ribbon from fingers and other foreign objects

IMPEDANCE/PHASE

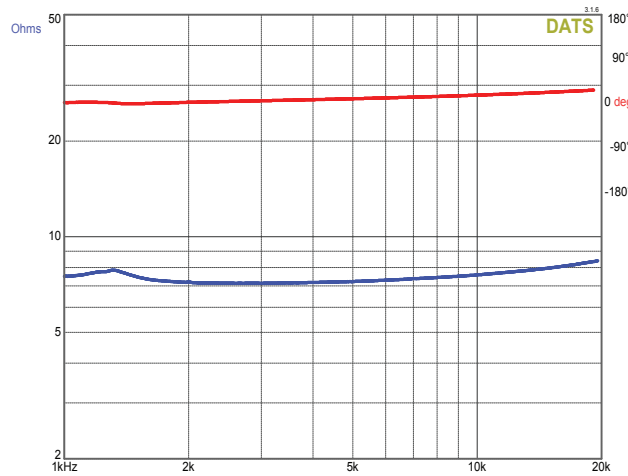

PARAMETERS

Impedance	8 ohms
Re	0.2 ohms
Le	N/A
Fs	N/A
Qms	N/A
Qes	N/A
Qts	N/A
Mms	N/A
Cms	N/A
Sd	N/A
Vd	N/A
BL	N/A
Vas	N/A
Xmax	N/A
VC Diameter	N/A
SPL	96 dB @ 2.83V/1m
RMS Power Handling	30 watts/60 watts max
Usable Frequency Range (Hz)	2,300 Hz - 40,000 Hz

FREQUENCY RESPONSE

